

Verrastung VS

Snap mechanism VS

Profil Vergrendeling VS

Enclenchement VS

Bloccaggio VS

стоп VS

Mechanizm zatraskowy VS

Wichtig! Bitte mit der Pflegeanleitung aufbewahren!

Important! Please keep together with care

instructions!

Belangrijk! A.u.b. bij de gebruiksaanwijzing bewaren!

Important! Conserver ensemble avec les conseils d'entretien!

Important! Conservare con le istruzioni per la manutenzione!

Важное указание! Просьба хранить вместе с руководством по уходу!

Uwaga! Proszę postępować zgodnie z instrukcją użytkowania!

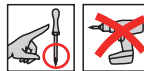

Demontage•Disassembly•Demontage•Démontage
Smontaggio•Демонтаж•Demontaż

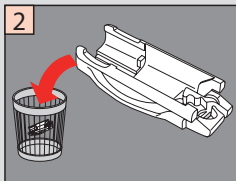
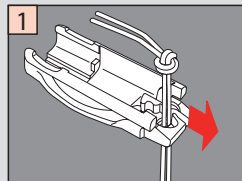

Montage•Fitting
Montage•Montaggio
Монтаж•Montaż

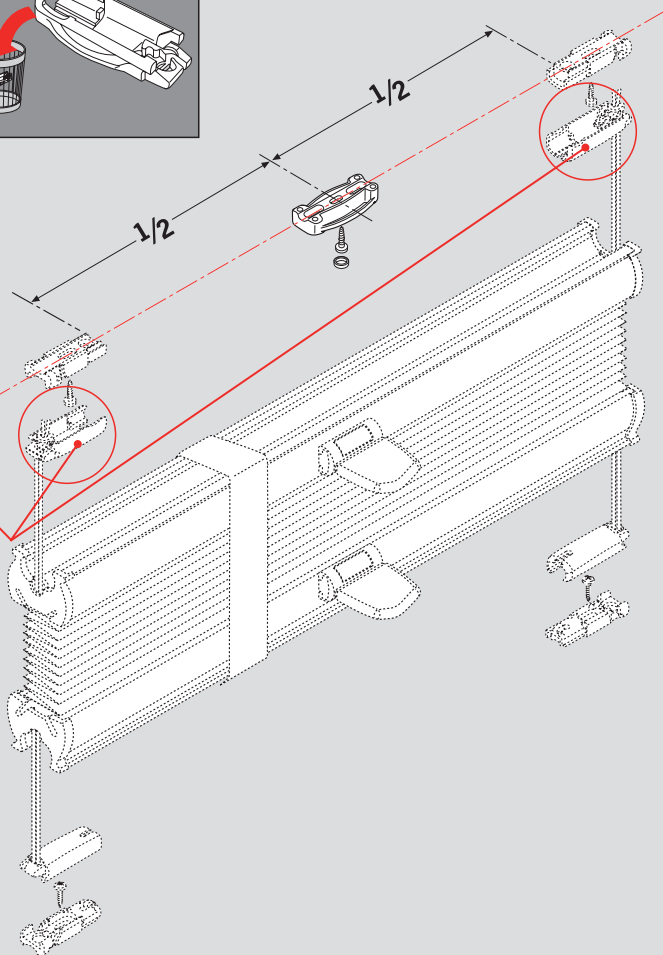
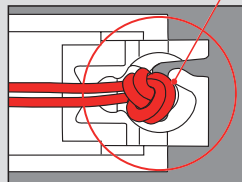
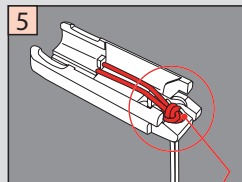
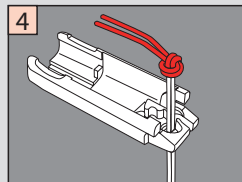
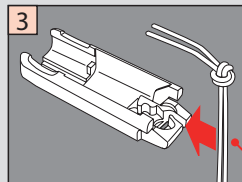

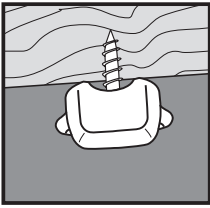



**Falzmontage,
Top fixing,
Bewestiging in de sponning,
Dans la feuillure,
Montaggio nella piegatura,
Образование складок,
Montaż na ramie okiennej.**



Montage-Fitting
Montage-Montaggio
Монтаж-Montaż

-  2,2 mm Ø
-  2,0 mm Ø
-  1,5 mm Ø

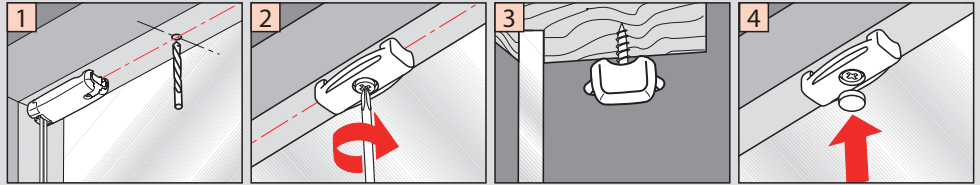
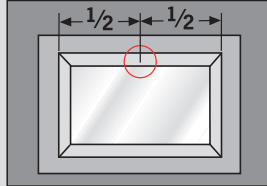

Schließen•Close•sluiten•Fermeture
Chiusura•закрывать•Zamykanie

Öffnen•Open•Openen•Ouverture
Apertura•открывать•Otwieranie

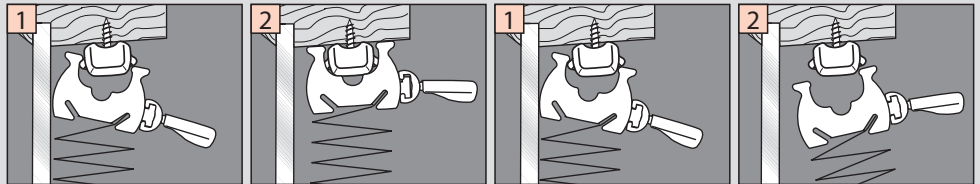

Demontage•Disassembly•Demontage•Démontage Smontaggio•Демонтаж•Demontaż

